

Modular Ultra High Density Panels | G-Connect Series

These panels are designed to accommodate Base-8 and Base-12 variety solutions in a high density and new generation structure. The modular construction combines highest port density with installation ease. A maximum of 144 LC connections can be stacked in 1U height, within 12 UHD cassettes.

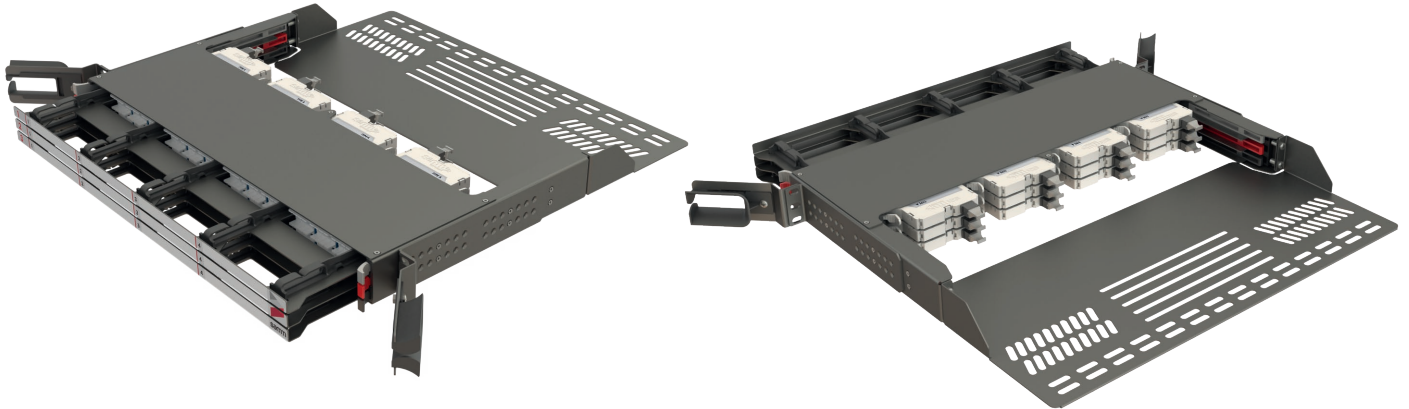

Features

- Modular structure with many different variations
- Configurable tray structure for Base-8 and Base-12 topologies
- Patented Rail Design
- In 1U 144 LC connector capacity
- 3 individually sliding trays per 1U for maximum flexibility during operation and installation
- Patch cord management for each individual tray
- Labelling front for module identification
- Sliding and extracting the modules of the trays for better access to cables during installation
- Modules can be removed and installed from the front and rear side of the trays

Dimensions

With Organizer

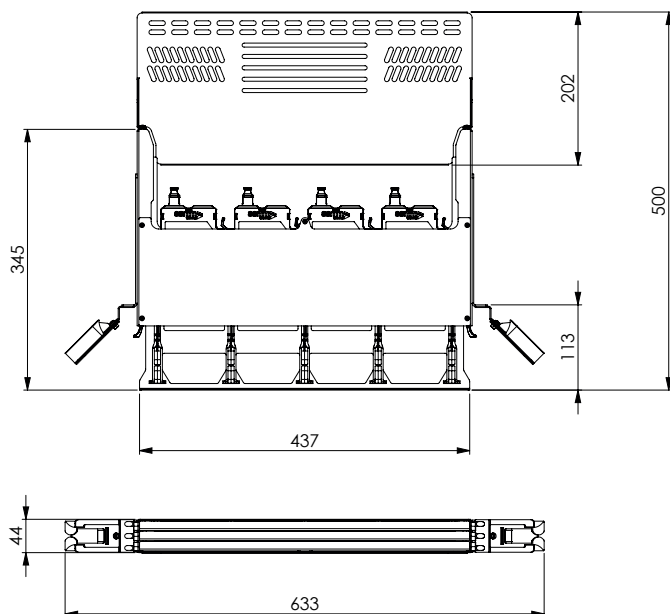

Without Organizer

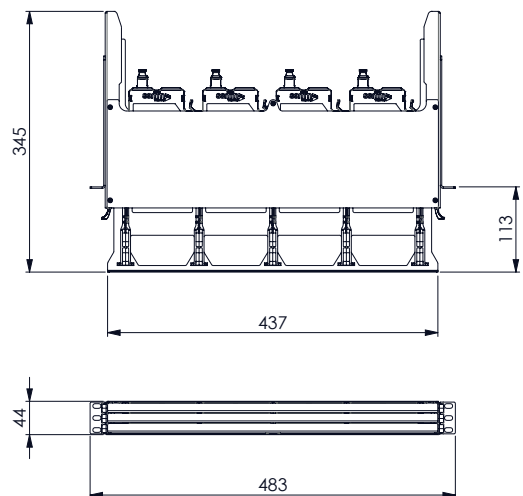

Different Backbone Design Options

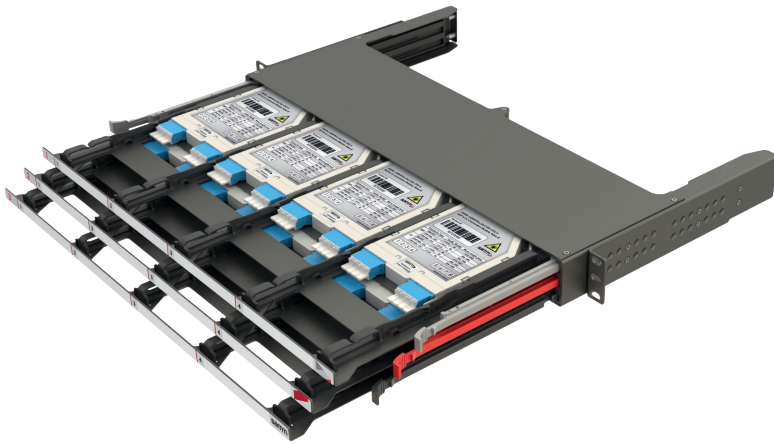
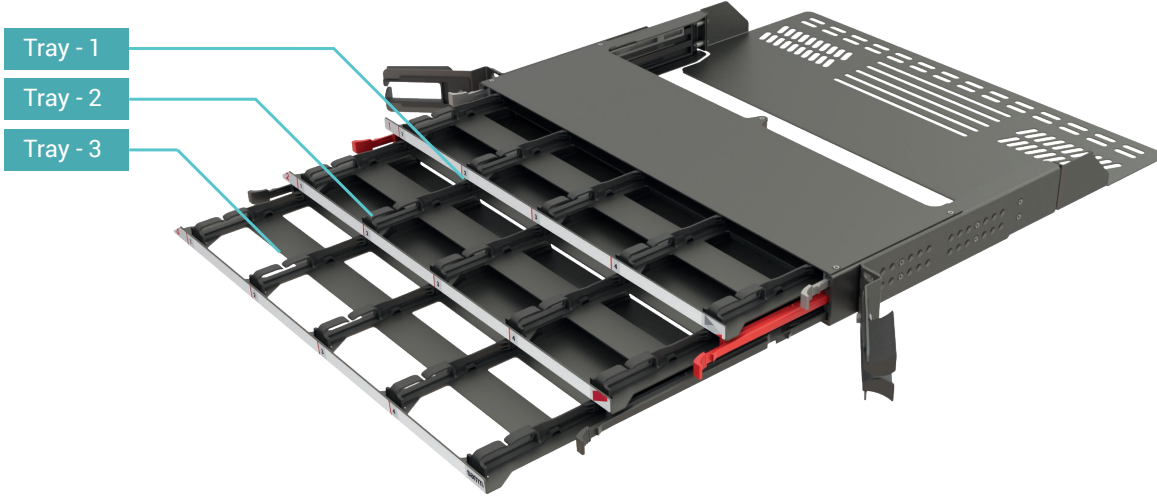

Base-8 Cassette Module

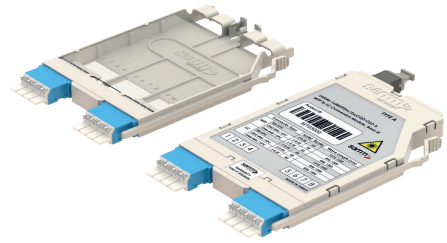

Base-12 Cassette Module

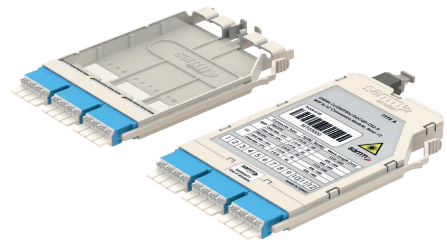

Practical Benefits

Sliding Tray Lock & Release Arm (Patent Pending)



Tray Move-Out Lock Releasing (Patent Pending)

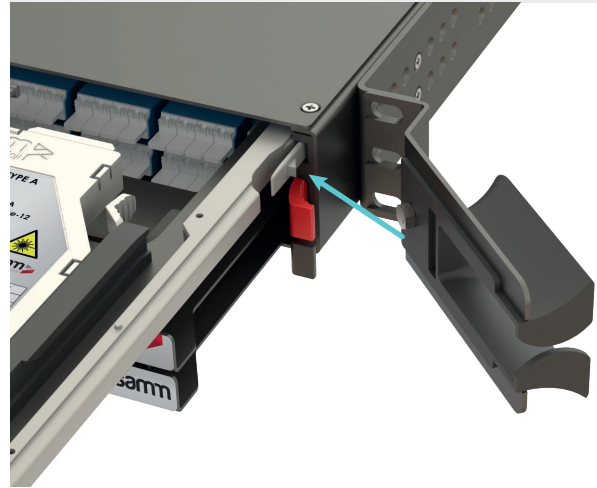

Front Cable Guides



Rear Organizer

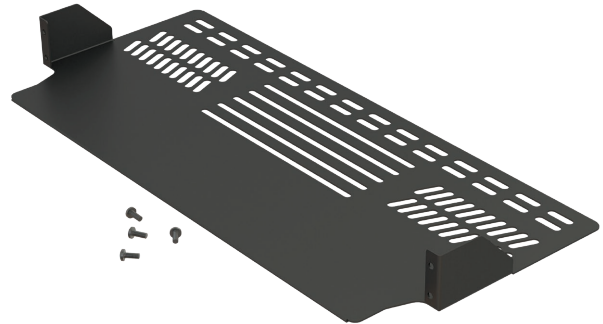

Order Coding

PAN-UHD-1U-B12-BLK-NN	19" 1U G-Connect UHDM Panel, Black, 12 Module Capacity, Base-12
PAN-UHD-1U-REAR-ORG	19" 1U G-Connect UHDM Panel Rear Organizer, Black
PAN-UHD-1U-FRONT-GUI	19" 1U G-Connect UHDM Panel Left/Right Front Cable Management Guides